



This brochure is provided by Betech

Flexitallic® is a market leader in the manufacture of static sealing solutions, delivering high quality industrial gaskets on a global scale, including acknowledged products and materials such as Sigma®, Thermiculite®, Corriculite® and Flange Rescue Gasket.

**Betech is Allied Distributor
for Flexitallic®**

Feel free to ask us about product choice, application, customization, supply etc.



Denne brochure er udleveret af Betech

Flexitallic® er en markedsleder inden for fremstilling af statiske tætningsløsninger og leverer industripakninger af højeste kvalitet på globalt plan. Programmet omfatter anerkendte produkter og materialer som Thermiculite®, Sigma®, Corriculite®, Spiral Wound Gaskets og Flange Rescue Gasket.

**Betech er Allied Distributor
for Flexitallic®**

Spørg os gerne om produktvalg, individuel tilpasning, levering etc.

Betech

Polymers and Sealing Solutions

www.betechseals.com

Tel.: +45 4485 8100

Mail: info@betech.dk

Vesterlundvej 4, DK-2730 Herlev (Copenhagen)

Industrivej 29, DK-6740 Bramming (Esbjerg)

Storgata 69, N-9008 Tromsø (Norway)

Flexitallic[®]

POWER TO THE FUTURE

FLEXITALLIC SEALING SOLUTIONS FOR **HYDROGEN** SERVICE.



www.flexitallic.com



INTRODUCTION

There is significant worldwide momentum behind hydrogen as a major carbon friendly feedstock and energy vector. Energy security and strategic economic interests are further boosting the interest in hydrogen. Current hydrogen consumption is driven by oil refining, fertilizer manufacturing, and methanol production. However, the need to decarbonise industrial processes and energy systems means the demand for hydrogen will grow dramatically over the next decade, cleaner production routes will be employed, and new technologies will enter the market.

The introduction of new technologies and systems as well as the conversion of existing infrastructure for producing, transporting, storing, and using hydrogen and its derived products (e.g., ammonia, liquid organic carriers, synthetic fuels) demand high grade sealing materials and gasket designs.

Sealing hydrogen presents two major challenges due to the unique properties of hydrogen. First, hydrogen is a very small molecule, meaning that gasket materials must have tight internal structures and good ability to conform to mating flanges. Second, hydrogen is highly flammable and explosive, thus requiring extremely reliable sealing.

THE HYDROGEN SECTOR

Today, the majority of the 94 Mt/y hydrogen is produced directly by the consumers for internal use (*captive hydrogen*) by Steam Methane Reforming (SMR) or Auto Thermal Reforming (ATR), a high temperature and high-pressure process (approx. 800°C and up to 300 bar) in which natural gas is split into hydrogen (H₂) and carbon dioxide (CO₂). The CO₂ is released to the atmosphere, and the H₂ is referred to as Grey Hydrogen. New production routes are emerging to reduce the carbon footprint of hydrogen production:

1. **Green Hydrogen** – produced by the electrolysis of water powered by renewable electricity typically from wind or solar. PEM and alkaline processes are relatively low temperature (around 80°C, and up to 40 bar), whereas Solid Oxide is much higher (650-900°C, and close to atmospheric pressure).
2. **Blue Hydrogen** – uses carbon capture and storage for the carbon dioxide gas produced in the creation of grey hydrogen.

The H₂ produced from renewable electricity and the CO₂ from blue hydrogen production will be stored in repurposed offshore gas fields, salt caverns as well as purpose-built tank systems (at pressures around 200-400 bar). More hydrogen will be produced centrally and then traded (merchant hydrogen). Transport and distribution will take place through existing, repurposed, pipework infrastructure as well as dedicated new networks and tankage. Pressures are expected to range between 60 and 80 bar in transmission systems. For long distance transport, where pipelines are not an option, hydrogen can be transported in liquid form (-253°C), or in the form of derivatives such as ammonia, methanol, or synthetic kerosene.

On top of the applications where hydrogen is already used today, hydrogen will be used to supply high-temperature heat to new industrial sectors (e.g., metallurgical, glass and ceramic industries). Hydrogen is likely to have a role in many sectors beyond industrial applications, such as the transport, buildings, and power sectors. Among these, some applications, such as shipping and aviation, have limited decarbonisation alternatives available. New technologies (e.g., fuel cells) or adapted existing ones (e.g., internal combustion engines, gas turbines and boilers) are already entering the market.

Although the focus is on hydrogen, other media are also present in the hydrogen sector. We have mentioned carbon dioxide and natural gas, however in the case of electrolysis in addition to hydrogen, ultra-pure water is split into a considerable volume of oxygen. This, as well as lye solution of alkaline electrolyzers, must also be handled safely. Moreover, hydrogen derivatives will be handled and traded in larger volumes.

FLEXITALLIC SEALING SOLUTIONS FOR HYDROGEN SERVICE

Flexitallic manufactures sealing solutions for hydrogen production, transport, storage, and use, which:

- Match the operating conditions of technologies and systems along the whole hydrogen value chain.
- Provide significantly tighter sealing than commonly used legacy sealing technologies, thus increasing safety, environmental and economic benefits.
- Increase safety, thanks to API 6FB specification (Specification for Fire Test for End Connections).
- Allow significantly more energy to be stored in the bolted connection, mitigating long service, component relaxation.
- Provide **Best in Class** gasket resilience, enhancing sealing reliability in pressure/thermal cycling applications.
- Offer **Best Available Technology (BAT)**, high and low temperature sealing. Providing exceptionally reliable, high temperature sealing and connection tightness.
- Remove the potential for galvanic corrosion, common to graphite sealing solutions, and crevice corrosion found with PTFE sealing solutions.

FLEXITALLIC CORRICULITE®

Corriculite® is ideal for hydrogen and is incorporated into traditional sealing platforms such as Spiral Wound, Flexpro® and Change™ gaskets. Corriculite® is approved fire safe to API 6FB and is suitable for applications ranging from 150# to 2500# ASME class connections. Corriculite® also has a temperature range spanning -196°C to +260°C. Corriculite® spiral wound gaskets provide sealing tightness up to 1,000 times higher than graphite filled gaskets. Corriculite® also removes galvanic corrosion potential found with graphite gaskets and crevice corrosion found with PTFE resulting compromised sealing performance.

Independent testing has shown Corriculite® to perform at cryogenic temperatures in a range of different pressure conditions. Very low leakage was detected even at -196°C and 149 bar after three thermal cycles. (Ref MIN 024).

- Tightest material available on the market
- Inert material which protects your asset
- PFAS/PTFE free
- Easy adoption as Corriculite® is available in multiple proven gasket technologies.

Hydrogen Leakage comparison at room temperature, a flat line indicates no change in sealing performance during unloading.

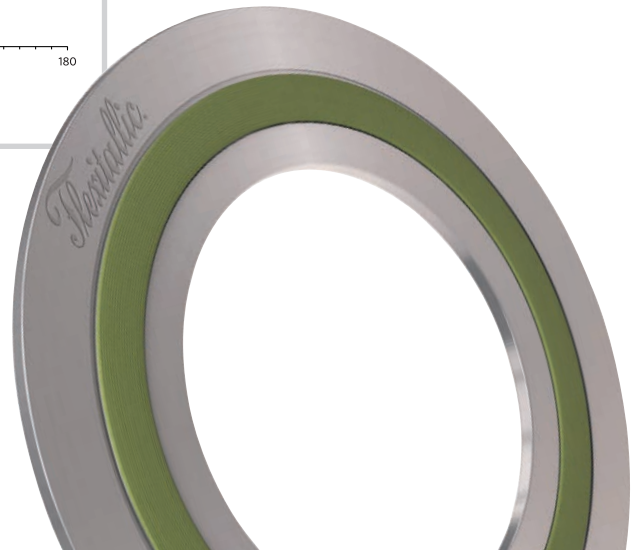
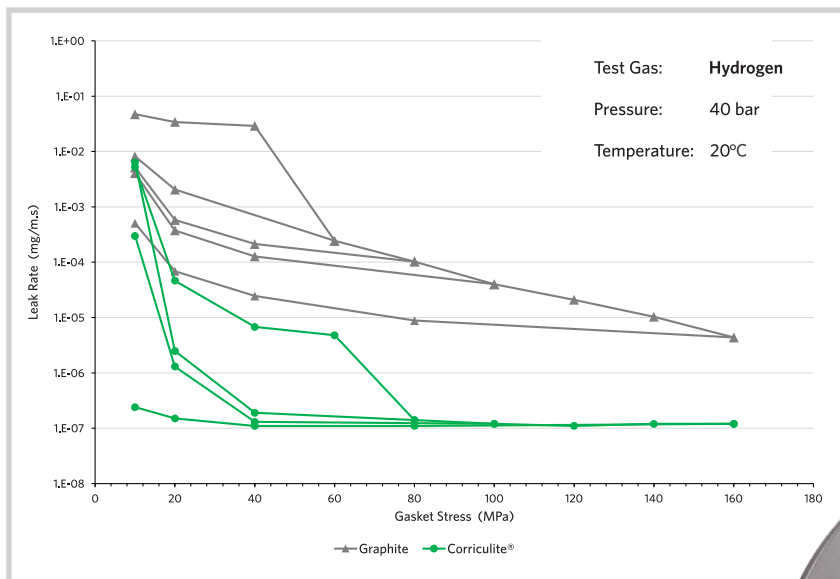

FLEXITALLIC THERMICULITE®

Thermiculite® is the only true high temperature sealing material and coupled with a 20-year success story means it is a proven solution for all extreme applications up to 1000°C. Thermiculite® was developed to reliably overcome the thermal oxidation problem associated with graphite and this has been repeatedly demonstrated in refining, chemicals, petrochemicals, OEM applications and many more besides.

Thermiculite® is incorporated in to multiple Flexitallic sealing platforms: Spiral Wound, Flexpro®, Change™ sheet, and cut gaskets. The specialist grades of Thermiculite® are used in solid oxide fuel cell and electrolyser stacks and systems offering unrivalled capability in hydrogen and oxidising environments over extended service life.

Thermiculite® is fire safe to API 6FB and is suitable for applications ranging from 150# to 2500#, and temperatures up to 1000°C. Thermiculite® gaskets are significantly tighter than graphite across the operating stress range. They are thermally and electrically isolating and provide long term, reliable high temperature performance even in thermal cycling.

Thermiculite®: Tightness vs Graphite in hydrogen

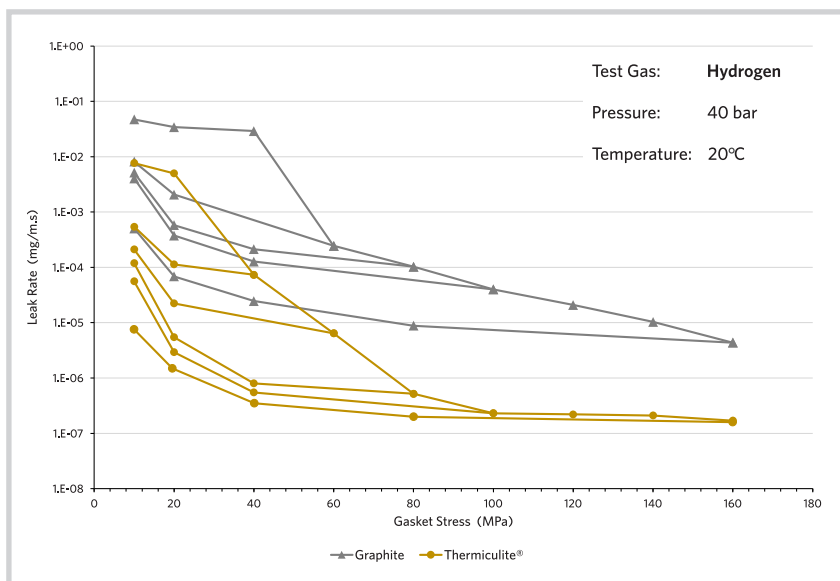

Thermiculite® 866 and 870 for Solid Oxide applications.

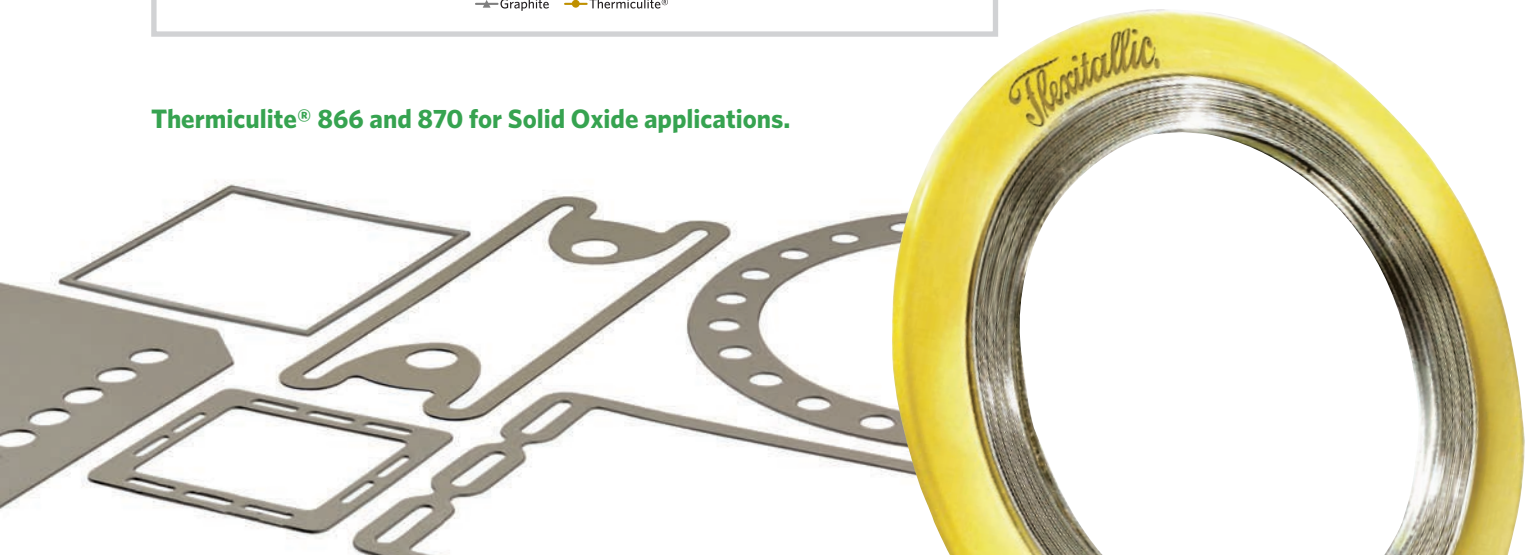

FLEXITALLIC CARRIER RINGS

For applications 150# to 2500#. Ideal for repurposing storage and distribution pipework, previously sealed with ring type joints. Carrier rings can be wound with either Corriculite® and Thermiculite®, depending on operating conditions.

Flexitallic's carrier ring technology uses spiral wound sealing elements providing best in class tightness and corrosion prevention.

Carrier rings seal on a different section of the RTJ flange, removing relaxation, work hardening, mechanical damage and galvanic corrosion issues associated with the RTJ sealing surface.

The carrier ring design is extremely resilient, improving long-term sealing reliability and preventing flange rotation possible with RTJs, at high assembly stresses.

Cross section of an RTJ flange showing the position of the spiral sealing elements of the carrier ring

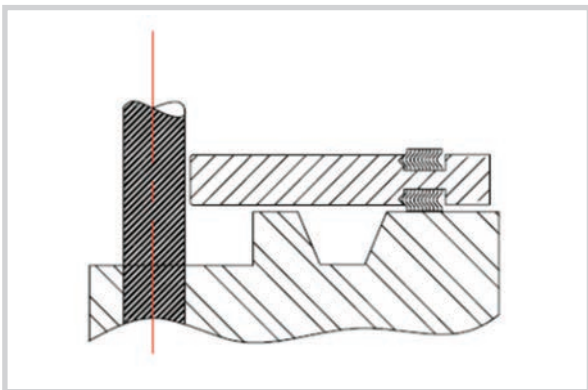

FLEXITALLIC CHANGE™

Originally designed to solve the issues associated with sealing shell and tube heat exchangers, Change™ gaskets offer BAT for all pressure cycling and thermally cycling applications, providing at least eight times the reliability of other sealing technologies. Fire safe to API 6FB, the Change™ gaskets outstanding resilience and strength enable the necessary stress to be maintained in the bolted connection and therefore reliable sealing, even under the most arduous cycling conditions. Change™ can be manufactured with both Corriculite® and Thermiculite® windings and facings, to meet application requirements.

Change™ gasket technology is written into the piping specification of a major gas producer, for Hydrogen service.

Shell Thermal Cycle test - Change™ sealing performance was tested and compared with other gasket sealing performance - 24 thermal cycles, ambient to 320°C and back to ambient, 1/2 day per cycle. 33 bar nitrogen applied. Test fail criteria is 1 bar pressure drop.

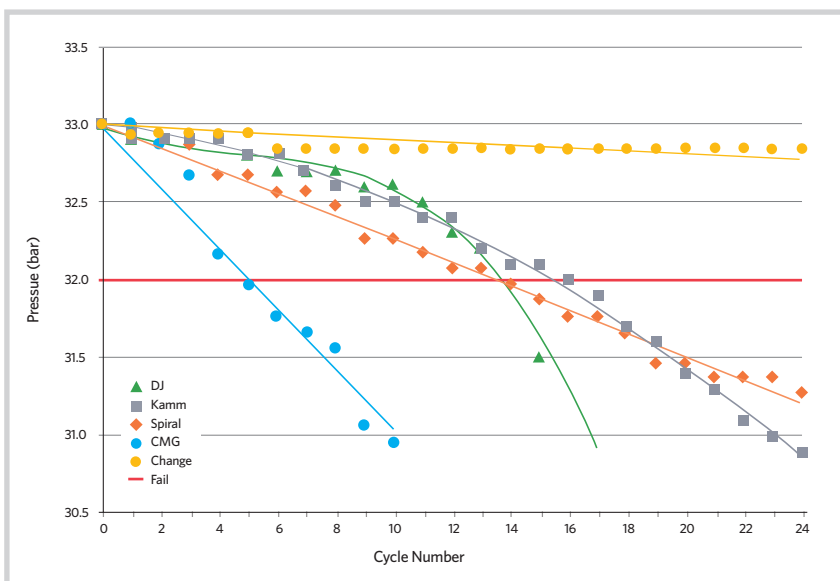

Flexitallic's Change technology reliably outperforms other market alternatives in cycling applications.



FLEXITALLIC ISOFLEX™-FS

The ISOFLEX™-FS design eliminates the concerns and pitfalls of existing products on the market. Provides best in class flange isolation and asset protection against galvanic corrosion. The sealing element of the IsoFlex isolation kit is faced with Corriculite®, making it corrosion resistant, API 6FB fire safe, and significantly tighter than other market alternatives. Isolation is achieved by the innovative design and incorporating high dielectric strength polyimide film.

A CLOSER LOOK AT ISOFLEX™-FS

Seal location is engineered to ideally position the sealing area more closely to the fasteners.

INNER RING: NEMA GRADE GRE

GRE components are auxiliary. Sealing is exclusively accomplished by faced serrations & polyimide isolation barrier.

DUAL Flexpro™ SEAL DESIGN (Kammprofile)

4X Wider Seal with Flexpro™ than Spring Energised Seals. Less susceptible to localized flange damage. Compressive load rests on the Flexpro™ (Kammprofile) to effect excellent tightness.

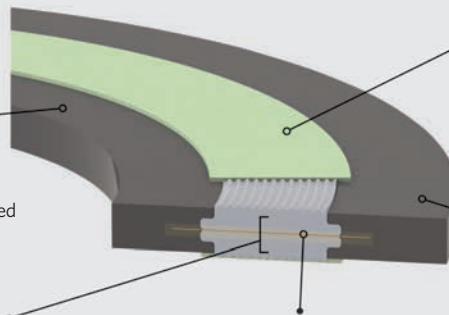

GASKET CORE: POLYIMIDE ISOLATION BARRIER

Excellent electrical resistance. Boasts a strong combination of thermal, chemical and mechanical properties.

Dielectric Strength (ASTM D149): 3000 V/mil.

Flexpro™ facings and polyimide isolation barrier extend beyond the metallic core.

CORRICULITE® FACINGS

Prevents the onset of galvanic corrosion and provides gas tight sealing performance with wide range of fluid compatibility.

- API 6FB Fire Safe.
- Inherently non-conductive.

OUTER RING: NEMA GRADE GRE

GRE components are auxiliary. Sealing is exclusively accomplished by faced serrations & polyimide isolation barrier.



UNITED KINGDOM **Flexitallic UK Ltd.**

Scandinavia Mill
Hunsworth Lane
Cleckheaton
West Yorkshire, BD19 4LN
UK
Tel. +44 1274 851273
www.flexitallic.com

*Branches also in Aberdeen,
Middlesbrough, Ellesmere Port
and South West.*

ITALY **Flexitallic Italy Sr.I**

Via Leonardo Da Vinci 6B
26020 Ticengo CR
ITALY
Tel. +39 0374 71006
Fax. +39 0374 71277
www.flexitallic.com

THAILAND **Flexitallic Sealing Technology Co Ltd.**

No. 7/456, Moo 6,
Amata City Rayong Industrial Estate
Mabyangporn Sub-district
Pluak Daeng District
Rayong Province
THAILAND
Tel. +66 (0)33017561 ~ 3
Fax. +66 (0)33017564
www.flexitallic.com

FRANCE **Siem Supranite** *a Flexitallic Company*

31-33 Rue de Mogador
75009 Paris
FRANCE
Tel. +33 (0)1 48 88 88 88
Fax. +33 (0)1 47 66 88 44
www.siem.fr

UNITED ARAB EMIRATES **Flexitallic LLC**

PO Box No. 6591-Al Jazeera
Plot 108, Road E
Al Hamra Industrial Area
Ras Al Khaimah
UNITED ARAB EMIRATES
Tel. +971 (0)7 202 5300
www.flexitallic.com

Branch also in Abu Dhabi.

AUSTRALIA **Flexitallic Australia Pty Ltd.**

13-15 Vinnicombe Drive
Canning Vale
Perth, WA 6155
AUSTRALIA
Tel. +61 (0)8 9455 2155
www.flexitallic.au

*Branch also in Melbourne,
Victoria.*

GERMANY **Flexitallic GmbH**

Halskestr. 13
47877 Willich
GERMANY
Tel. +49 (0) 2154 95363-0
Fax. +49 (0) 2154 95363-29
www.flexitallic.com

CHINA **Flexitallic Gasket Technology (Suzhou) Co., Ltd**

Building A, 1868 Guangming Rd
Technological Development Zone
Wujiang Economic 215200
CHINA
Tel. +86 512 6303 2839
Fax. +86 512 6303 2879
www.flexitallic.com

UNITED STATES **Flexitallic US LLC**

6915 Highway 225
Deer Park
Texas 77536
USA
Tel. +1 281 604 2400
Fax. +1 281 604 2415
www.flexitallic.com

MEXICO **Flexitallic Mexico/Equiter SA de CV**

Calle 28 #2571
Zona Industrial Bienestar Social
Guadalajara, Jalisco
MEXICO. CP 44940
Tel: +52 33 3145 3454/1763
www.flexitallic.com

BENELUX **Flexitallic Benelux BVBA**

Smallandlaan 21
2660 Hoboken
BELGIUM
Tel. + 32 3 369 19 68
www.flexitallic.com

SINGAPORE **Flexitallic Ltd.**

Singapore Branch
Level 42 Suntec Tower Three
8 Temasek Boulevard
SINGAPORE
038988
Tel. +65 68663638
www.flexitallic.com

CANADA **Flexitallic Canada Ltd.**

4340 - 78 Avenue
Edmonton
Alberta, T6B 3J5
CANADA
Tel. +780 466 5050
Fax. +780 465 1177
www.flexitallic.com

About The Flexitallic Group

The Flexitallic Group is a global leader in specialised sealing solutions and products serving the oil and gas, power generation, chemical and petrochemical industries in emerging and developed markets. Focused on the upstream, downstream and power generation sectors, it has operations in France, the United States, Canada, Mexico, the United Kingdom, Germany, Italy, Belgium, the United Arab Emirates, Thailand and China plus a network of worldwide licensing partners and distributors.



This brochure is provided by Betech

Flexitallic® is a market leader in the manufacture of static sealing solutions, delivering high quality industrial gaskets on a global scale, including acknowledged products and materials such as Sigma®, Thermiculite®, Corriculite® and Flange Rescue Gasket.

**Betech is Allied Distributor
for Flexitallic®**

Feel free to ask us about product choice, application, customization, supply etc.



Denne brochure er udleveret af Betech

Flexitallic® er en markedsleder inden for fremstilling af statiske tætningsløsninger og leverer industripakninger af højeste kvalitet på globalt plan. Programmet omfatter anerkendte produkter og materialer som Thermiculite®, Sigma®, Corriculite®, Spiral Wound Gaskets og Flange Rescue Gasket.

**Betech er Allied Distributor
for Flexitallic®**

Spørg os gerne om produktvalg, individuel tilpasning, levering etc.

Betech

Polymers and Sealing Solutions

www.betechseals.com

Tel.: +45 4485 8100

Mail: info@betech.dk

Vesterlundvej 4, DK-2730 Herlev (Copenhagen)

Industrivej 29, DK-6740 Bramming (Esbjerg)

Storgata 69, N-9008 Tromsø (Norway)